

mtl door

MTLdoor Installation Manual & Procedure

MTLdoor 安装手册及程序

SOLID

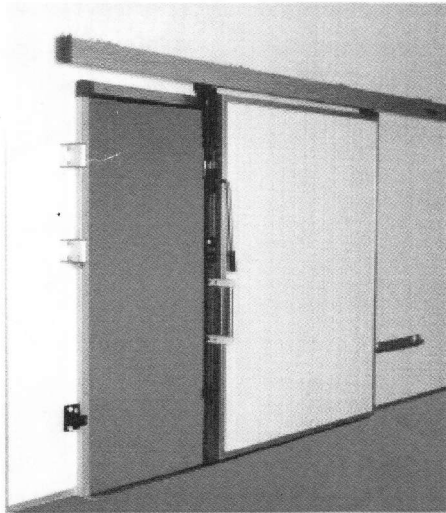

SUPERIOR



SMOOTH

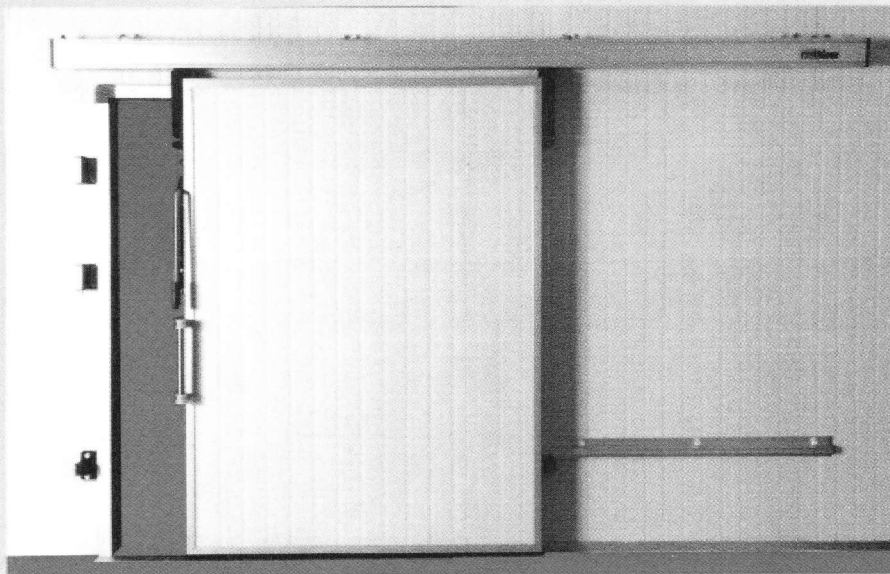

美達產品市場有限公司

MTL PRODUCTS MARKETING SDN. BHD. (459007-D)

STEELAND PRODUCTS MANUFACTURING SDN. BHD. (723020-V)

No. 2, Jalan Industri Mas 12, Taman Mas Sepang, 47130 Puchong, Selangor, Malaysia

Tel: +6(03) 8060 9503 / +6(03) 8060 9504 Fax: +6(03) 8060 9505

E-mail: info@mtlpm.com.my

Website: www.mtlpm.com.my



ISO 9001:2008



MS ISO/IEC 17021:2011
QS 02032013 CB 13

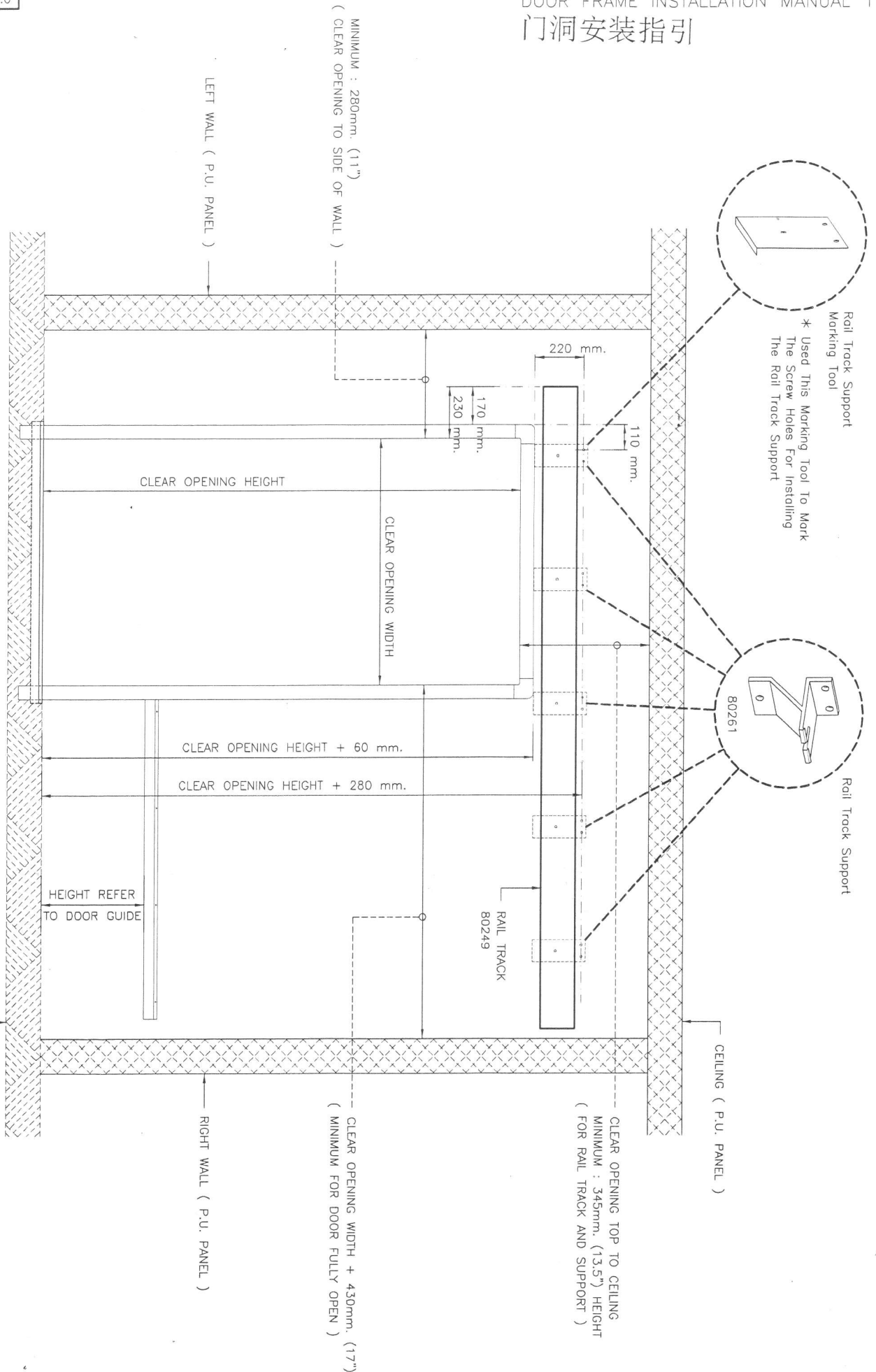

Rail Track Support Working Tool

* Used This Working Tool To Mark The Screw Holes For Installing The Rail Track Support

Rail Track Support 80261

Rail Track Support Installation Layout
门洞铝轨安装所需空间规划图

FRONT VIEW
门洞前方安装顺序图

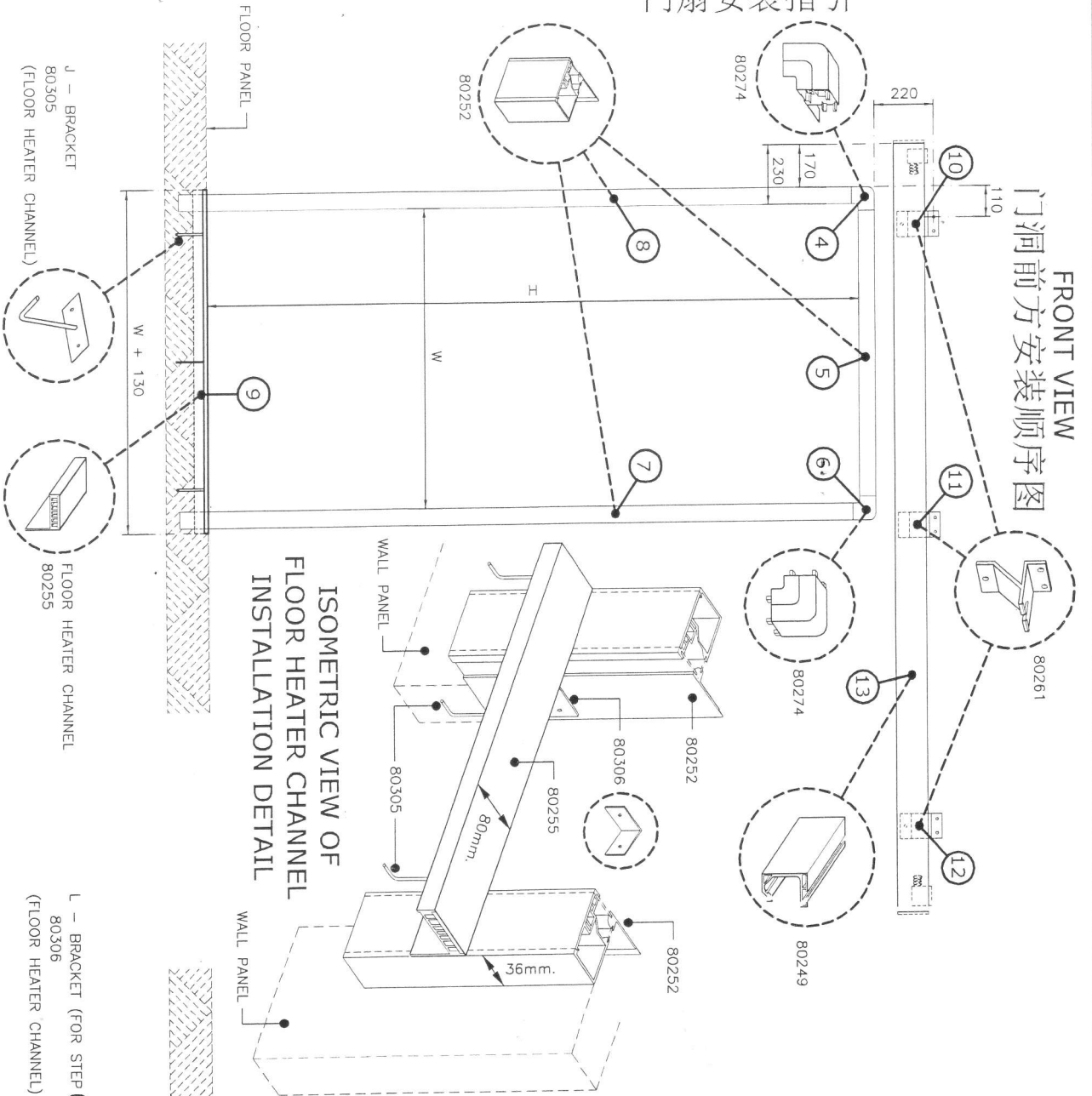

BACK VIEW
门洞后方安装顺序图

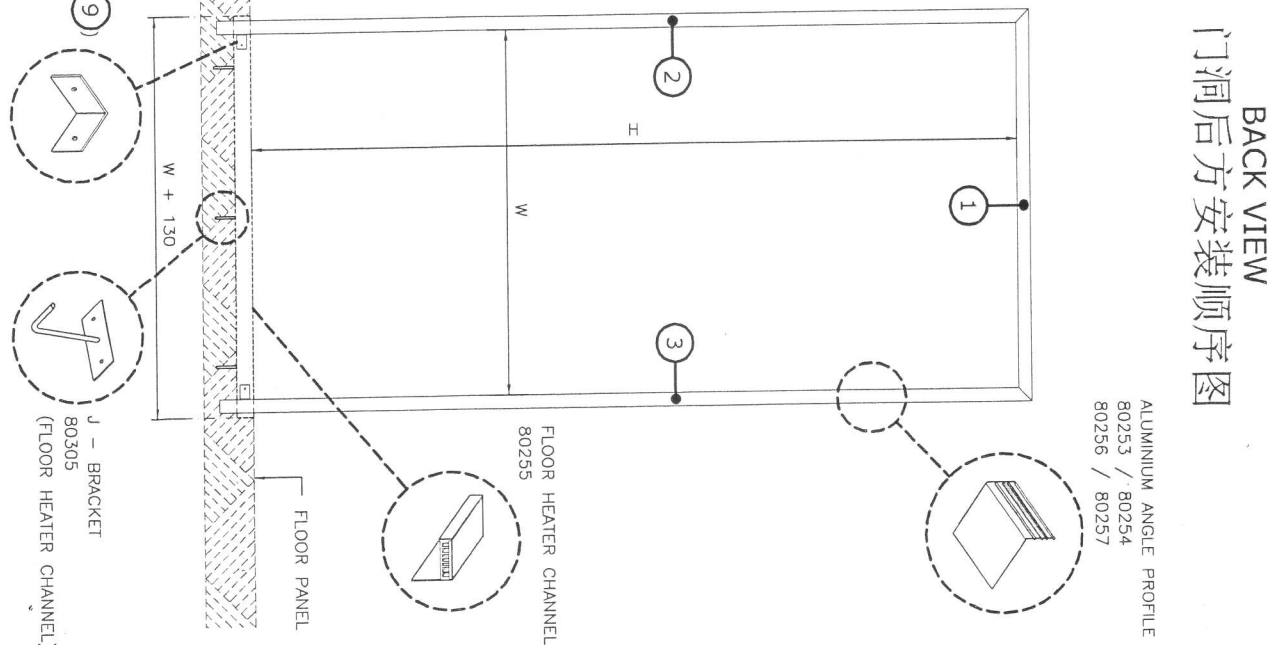

ISOMETRIC VIEW OF
FLOOR HEATER CHANNEL
INSTALLATION DETAIL

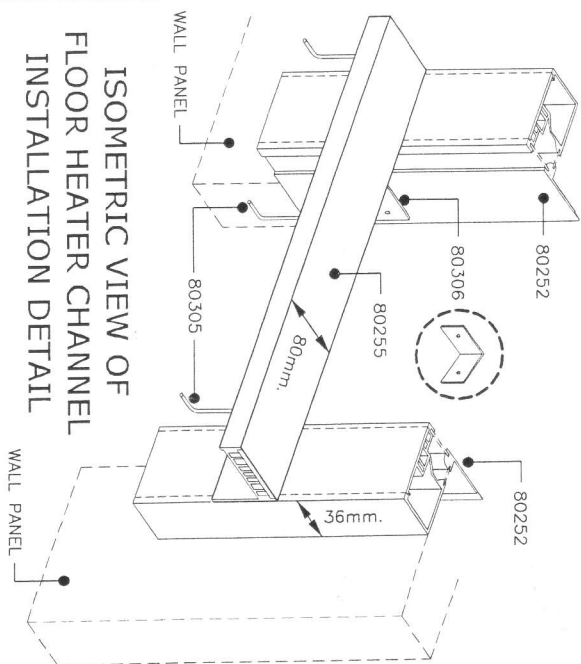

ALUMINUM ANGLE PROFILE
80253 / 80254
80256 / 80257

DOOR FRAME INSTALLATION LAYOUT (FRONT VIEW, BACK VIEW AND ISOMETRIC VIEW)
INSTALLATION SEQUENCE ACCORDING TO NUMBER

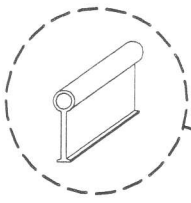

DOOR LEAF GASKET
80302

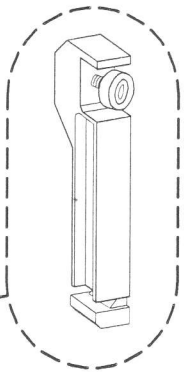

ADJUSTABLE NYLON
FIBER PULLEY (ø75mm)
80281 (R)
80282 (L)

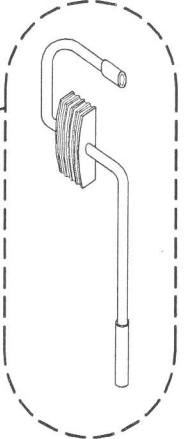

EXTERNAL HANDLE
80287

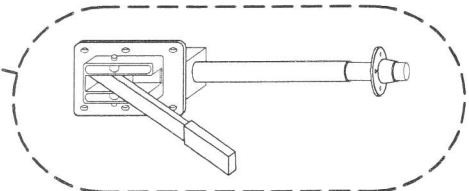

INNER EMERGENCY DOOR PULL
80290

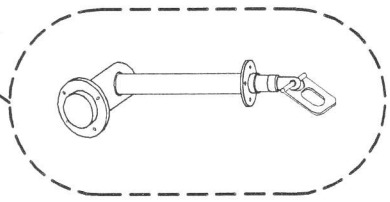

INNER EMERGENCY RELEASE LOCK
80295

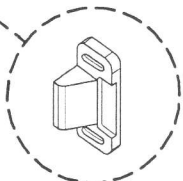

LOWER CLOSURE STRIKER
80268

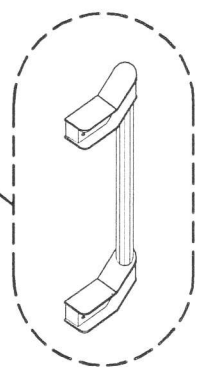

ARTICULATED EXTERNAL PULL
80298

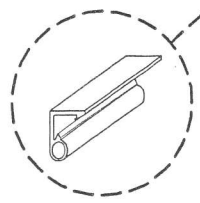
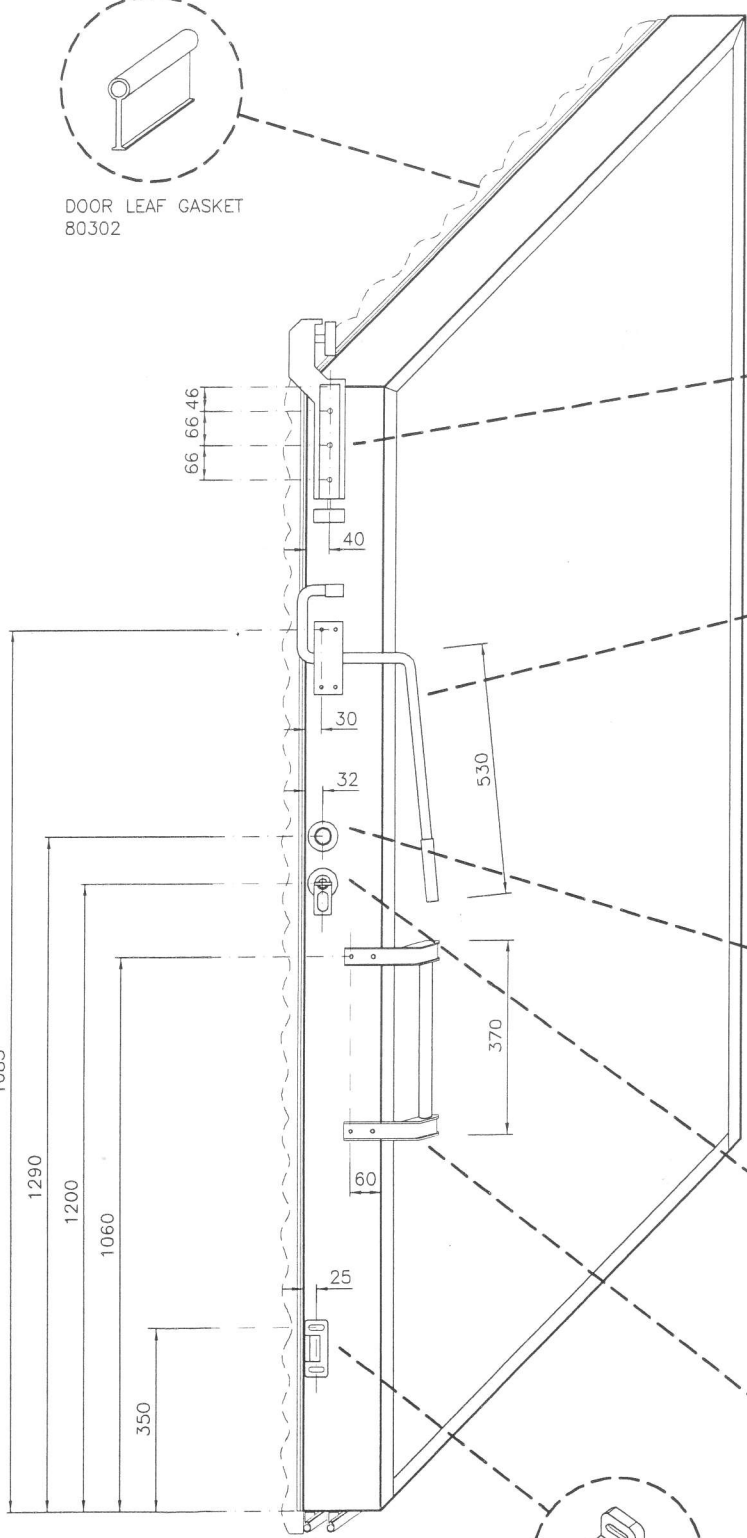

DOOR LEAF BOTTOM GASKET
80301

DOOR LEAF : LEFT VIEW
门扇左侧图

门扇安装指引

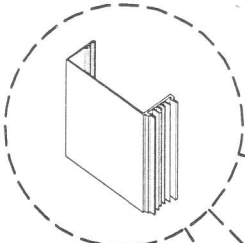

DOOR LEAF C-CAPPING
80307 / 80308 / 80309 / 80310
(FOR TIMBER FREE DOOR LEAF)

DOOR LEAF GASKET
80302

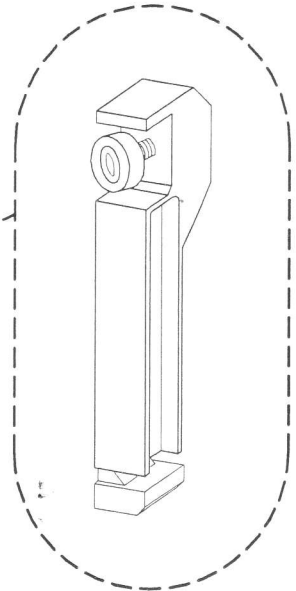

ADJUSTABLE NYLON
FIBER PULLEY (ø75mm)
80281 (R)
80282 (L)

DOOR LEAF GASKET CHANNEL
80258

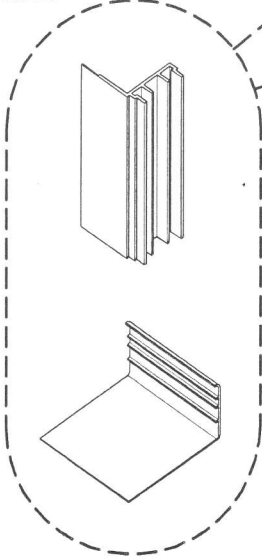

ALUMINIUM ANGLE PROFILE
80253 / 80254 / 80256 / 80257
(FOR TIMBER FRAME DOOR LEAF)

66 66 46

40

DOOR GUIDE WALL TYPE
80267

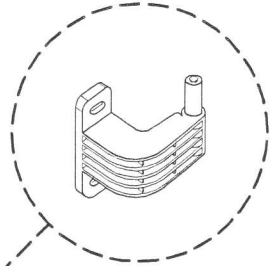

ALUMINIUM ANGLE PROFILE
(80253) WITH 2nos. DOOR
LEAF LOWER GASKET (80301)

20 350

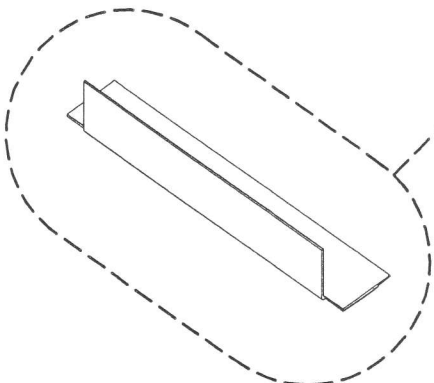

ALUMINIUM ANGLE PROFILE
80253

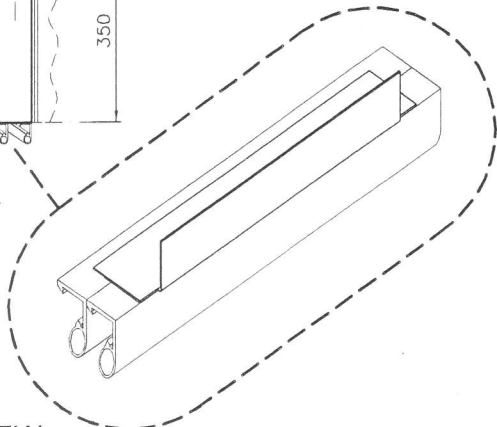

DOOR LEAF : RIGHT VIEW
门扇右侧图

INNER EMERGENCY RELEASE LOCK
80295

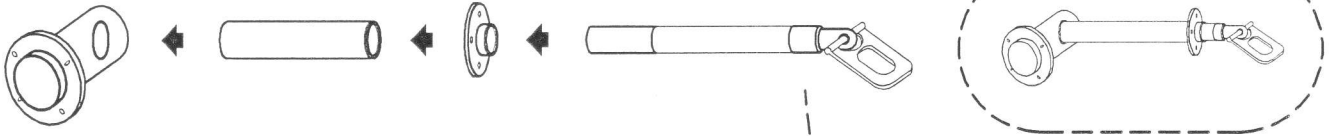

ARCH CHANNEL
(FOR TIMBER FREE DOOR LEAF)
80276TF (R & L)

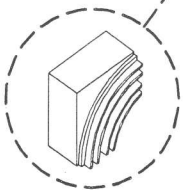

ARCH CHANNEL
(FOR TIMBER FRAME DOOR LEAF)
80276 (R & L)

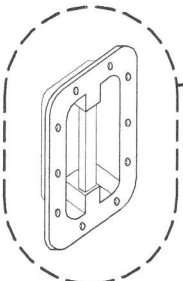

INNER DEEP SET DOOR PULL
80270

ALUMINIUM ANGLE PROFILE
(80253) WITH 2nos. DOOR
LEAF LOWER GASKET (80301)

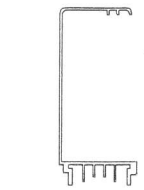
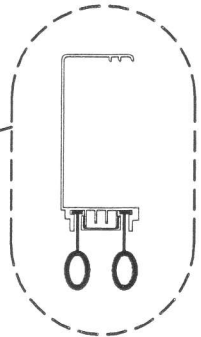
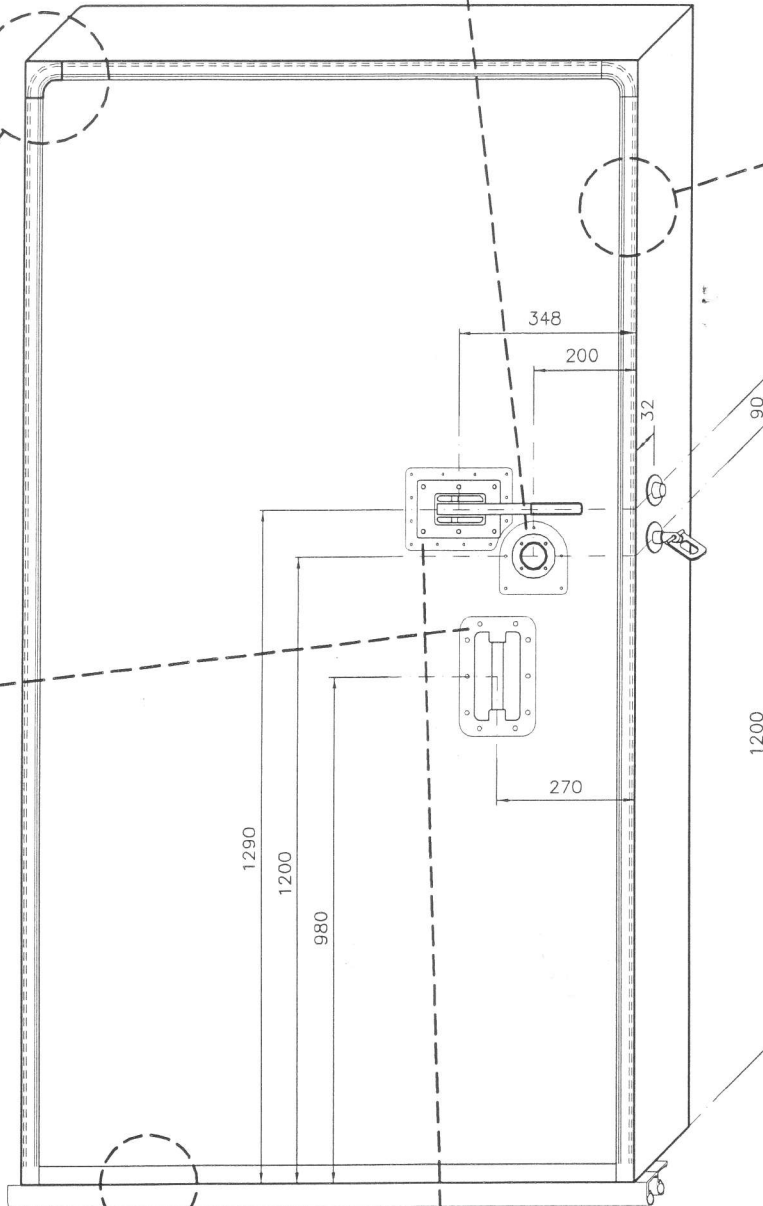
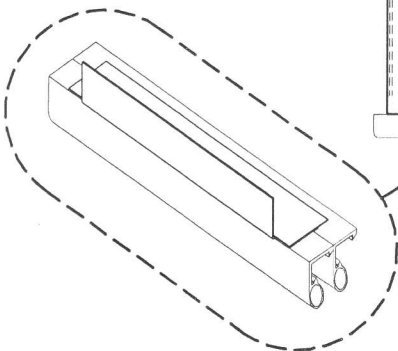

DOOR LEAF
C-CAPPING
80307 / 80308 /
80309 / 80310



DOOR LEAF GASKET
80302



GASKET U-CAPPING
80259

INNER EMERGENCY DOOR PULL
80290



DOOR LEAF : BACK VIEW
门扇后方图

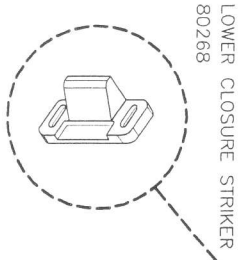

LOWER CLOSURE STRIKER
80268



LOWER CLOSURE HOOK
80268



EMERGENCY HANDLE STRIKER
80265

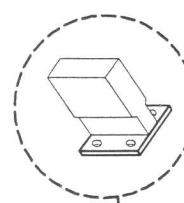

EXTERNAL HANDLE STRIKER
80266

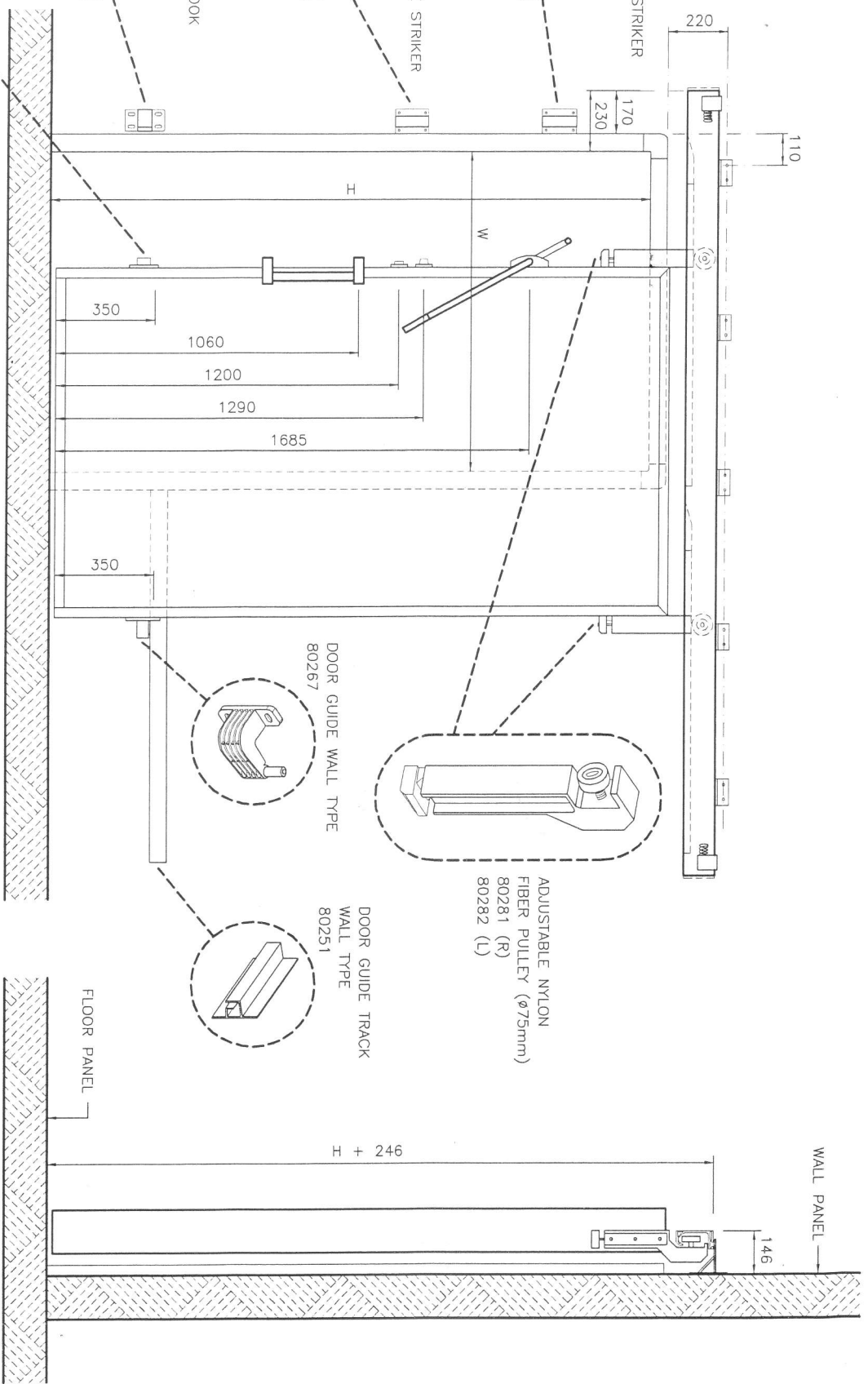

FRONT VIEW

SIDE VIEW

Door Frame And Door Leaf Completed Installation Layout
门洞及门扇安装完成图

超高门扇安装指引

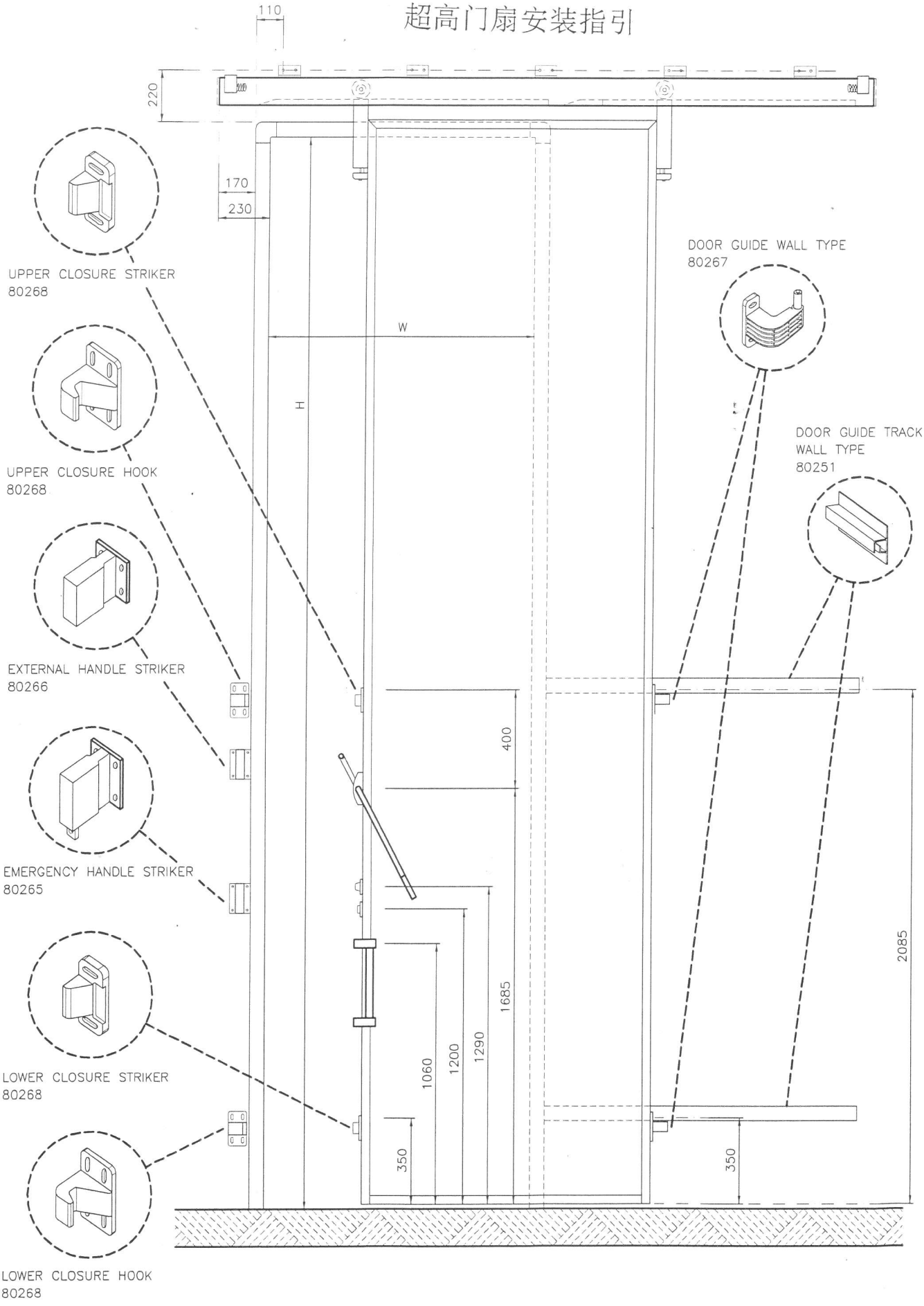

Door Leaf And Door Frame Installation Layout For Special Height
 超高门扇及门洞安装指引

DOOR LEAF AND DOOR OPENING DIMENSIONS

门扇及门洞尺寸对比图



Note : Door width is to be wider than Door Opening width by 3 1/2" (90mm).
Door height is to be higher than Door Opening height by 3/4" (19mm).

* Actual dimension for a 4' Door is 47 1/4" (1200mm).

Actual dimension for a 8' Door is 94 1/2" (2400mm).

注 : 门扇宽度比门洞宽度宽3 1/2" (90mm)
门扇高度比门洞高度高 3/4" (19mm)